



mökki LTD

INFO AND PRICE LIST
SPRING 2024



There are three basic Mökki models to choose from called Shelter, Quad and Tube. Each is available with different window and door configurations. The Quad also comes in three different sizes.



Mökki Shelter

- Suited to narrower spaces with the short side facing the garden or in exposed locations where the canopy provides some additional shelter.
- 6 different configurations.



Mökki Quad

- Suited to wider spaces with the long side facing the garden and the back pushed against a boundary.
- Our most flexible studio - 3 different sizes and multiple configurations.



Mökki Tube

- Model combining elements of both the Shelter and the Quad, available in 2 sizes.
- Small canopy provides additional shelter.
- Suited to narrow urban spaces with the short side facing the garden.
- Big enough for two people to work side by side.

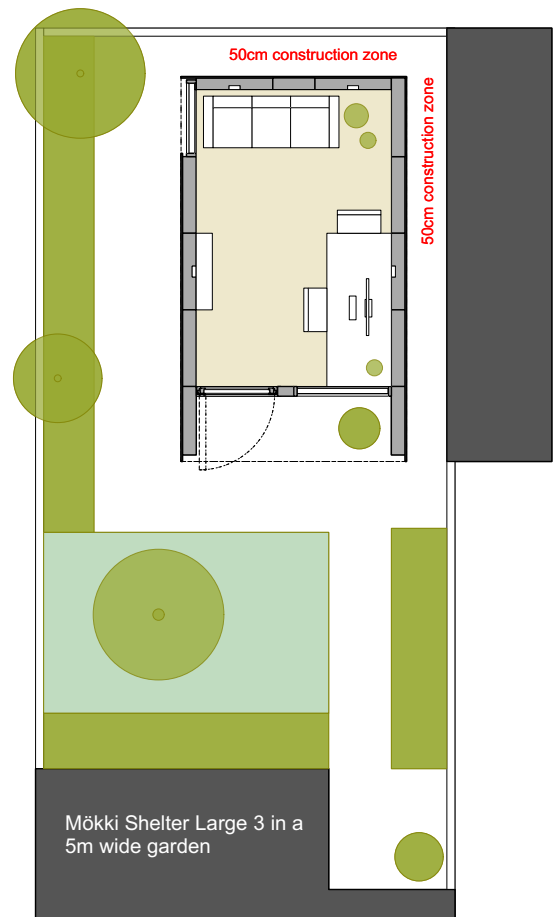

Example layouts

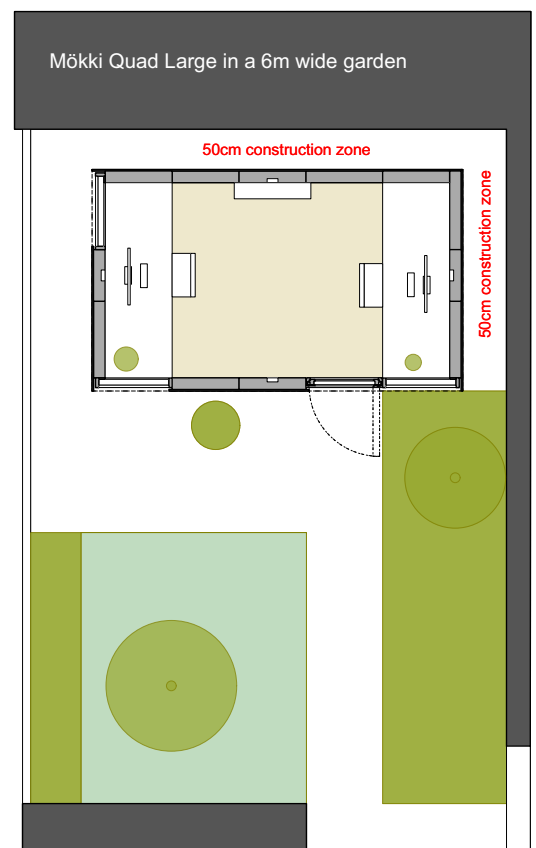

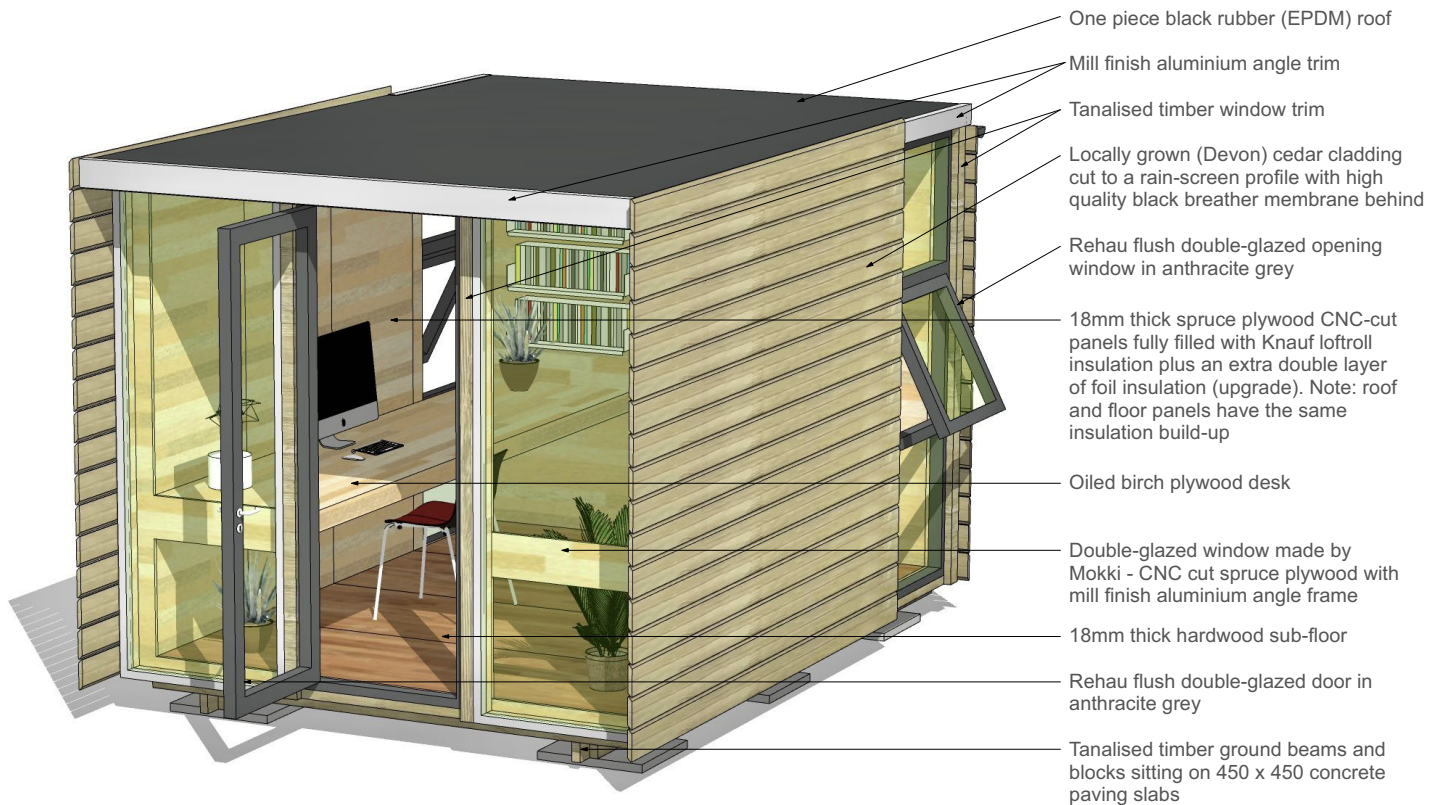

Illustrated is a Mökki Tube Compact - all studios are built to the same specification

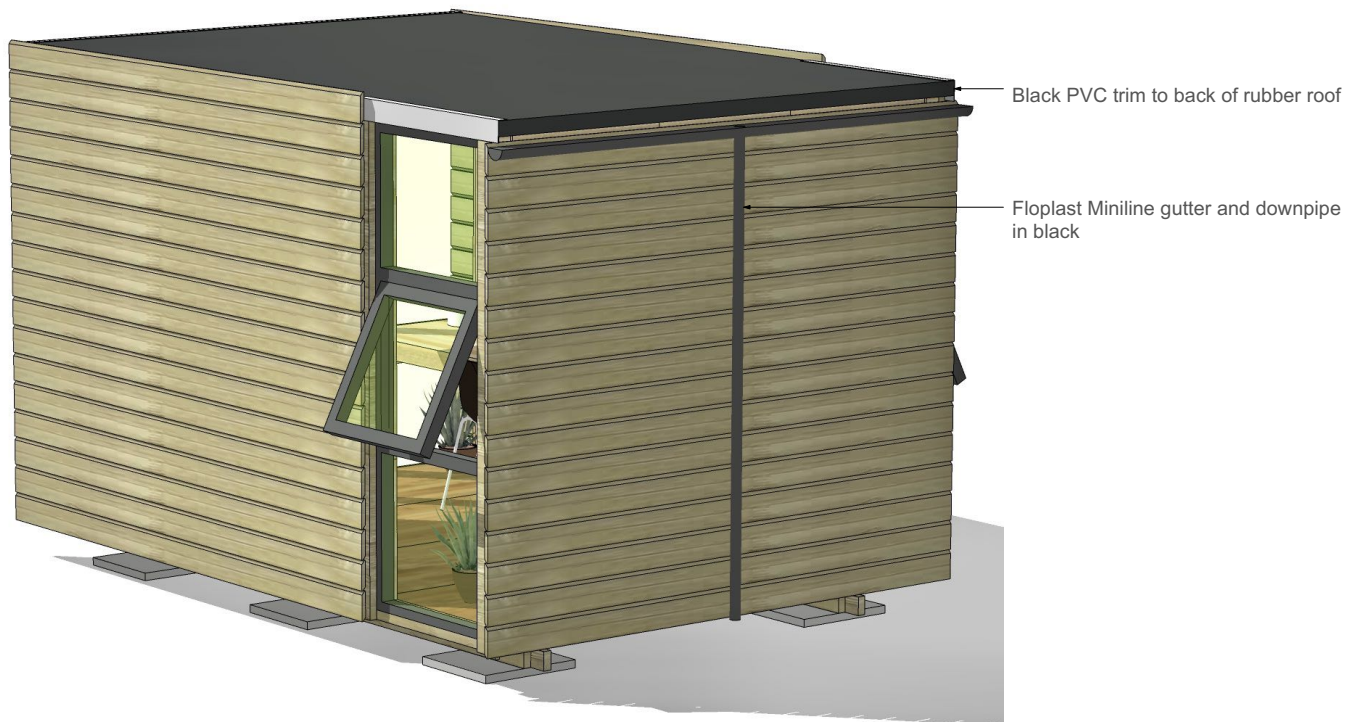

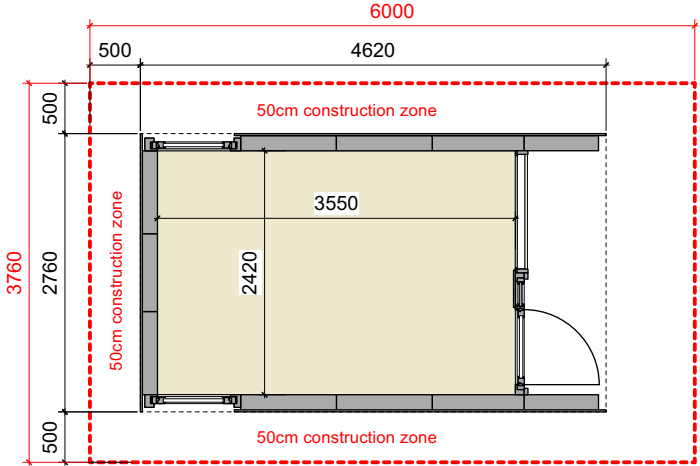

Mökki Shelter space required

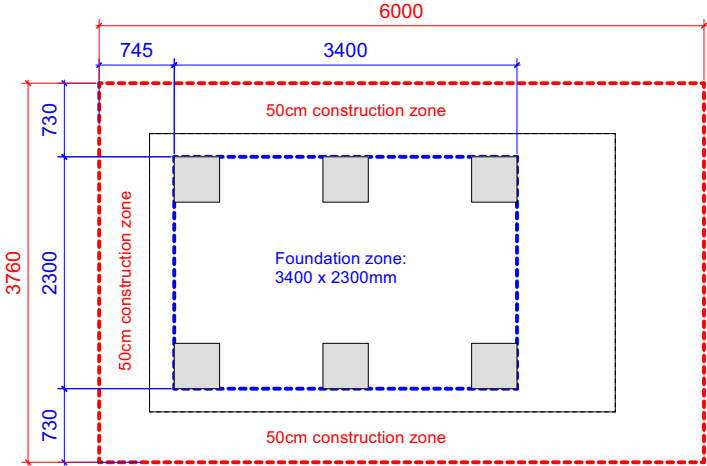

Mökki Shelter foundation area

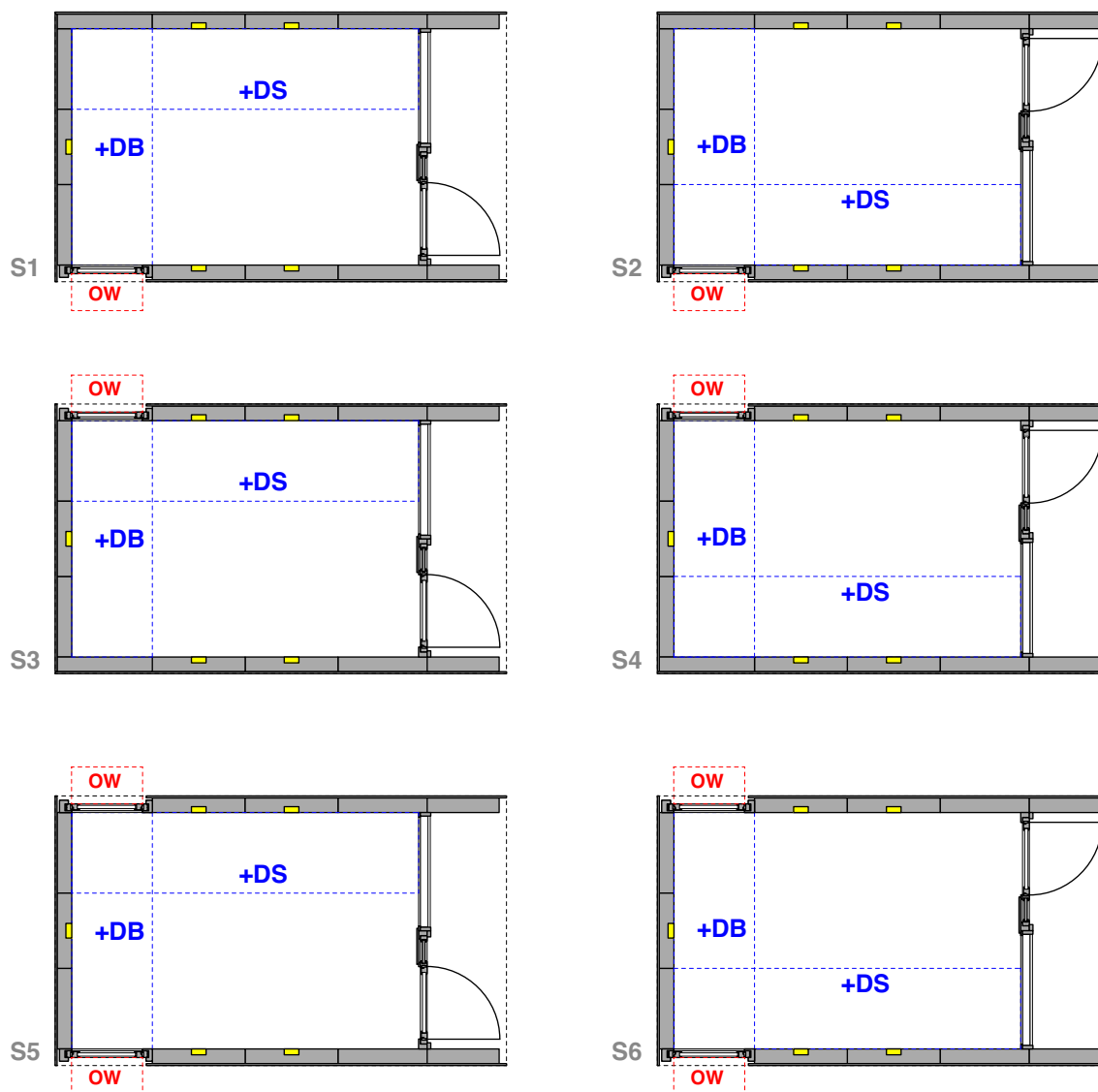

Key:

- OW** Opening window
- +DB** Standard oiled birch plywood desk to back
- +DS** Extra long oiled birch plywood desk to side
- Cut-out for double socket

Example ordering code: S5 + DS

Prices and Options:

S1, S2, S3 and S4	£18,000
S5 and S6	£18,750
Insulation upgrade	£350
Oiled birch plywood desk (DB)	£400
Extra long birch plywood desk (DS)	£750

Delivery charges vary - please refer to final page

All prices include VAT, foundations and installation

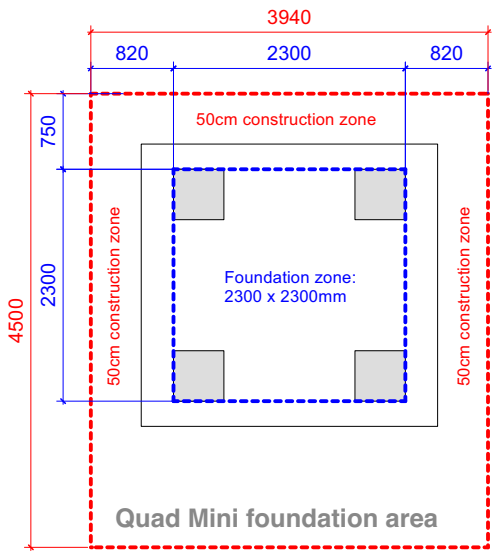
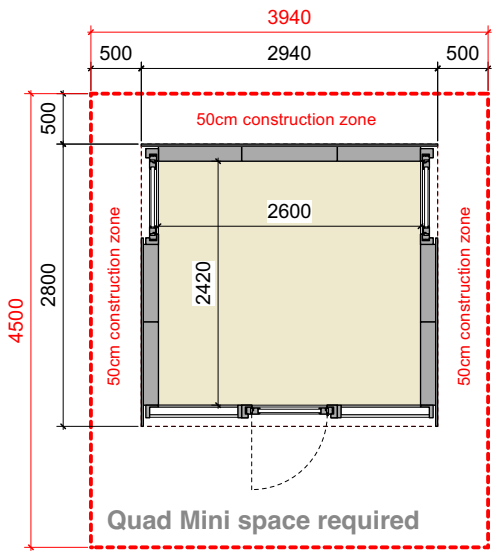

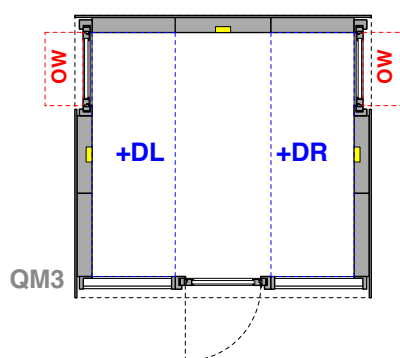
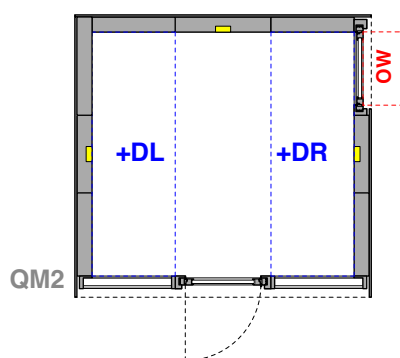
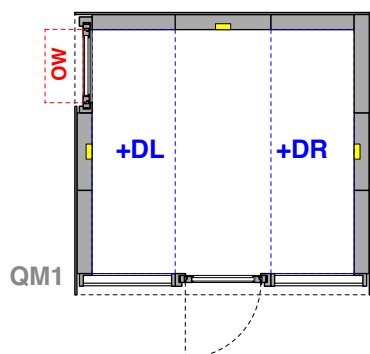

Key:

- OW** Opening window
- +DL** Optional oiled birch plywood desk on Left
- +DR** Optional oiled birch plywood desk on Right
- Cut-out for double socket

Example ordering code: QM1 +DR

Prices and Options:

QM1 and QM2	£14,500
QM3	£15,250
Insulation upgrade	£250
Oiled birch plywood desk	£400

Delivery charges vary - please refer to final page

All prices include VAT, foundations and installation

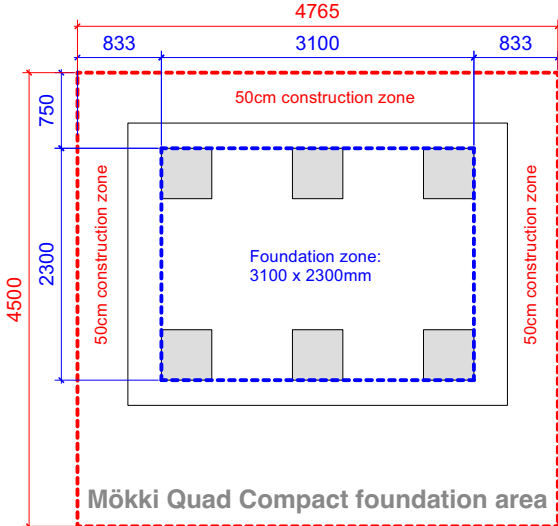
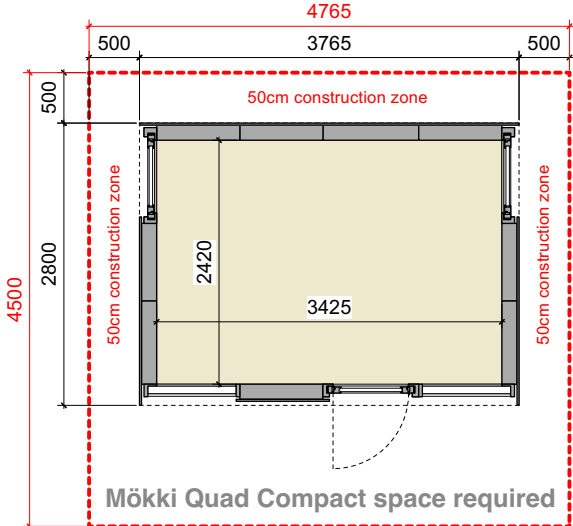

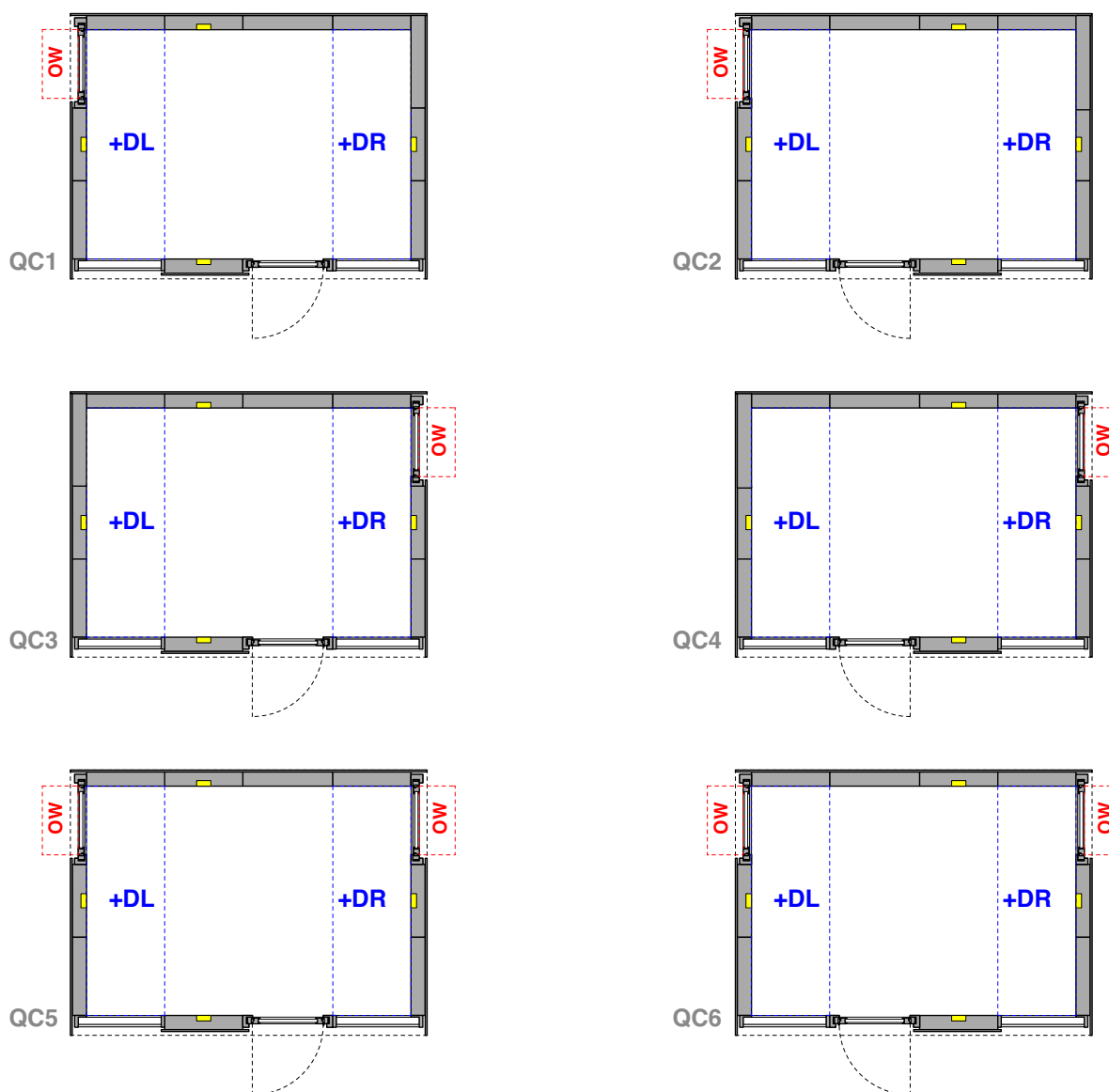

Key:

- OW** Opening window
- +DL** Optional oiled birch plywood desk on Left
- +DR** Optional oiled birch plywood desk on Right
- Cut-out for double socket

Example ordering code: QC1 +DR

Prices and Options:

QC1, QC2, QC3 and QC4 £16,750

QC5 and QC6 £18,000

Insulation upgrade £300

Oiled birch plywood desk £400

Delivery charges vary - please refer to final page

All prices include VAT, foundations and installation

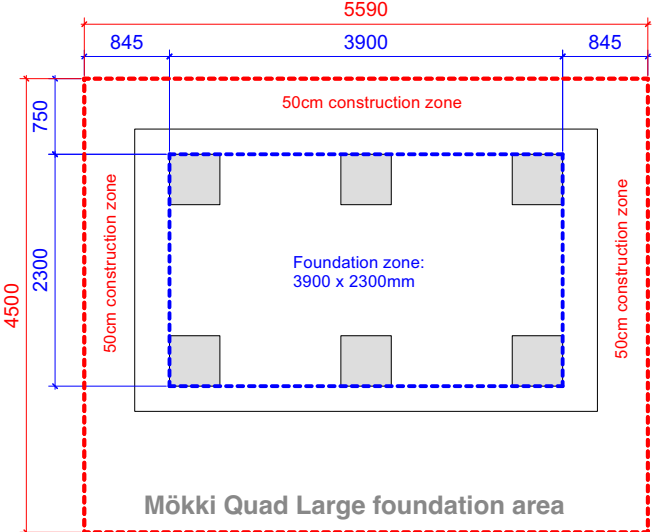
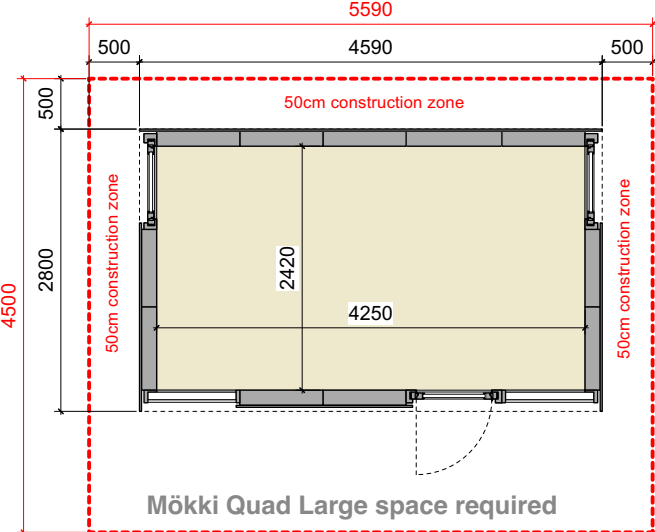

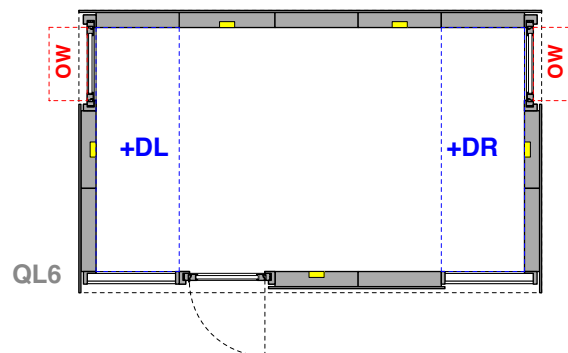
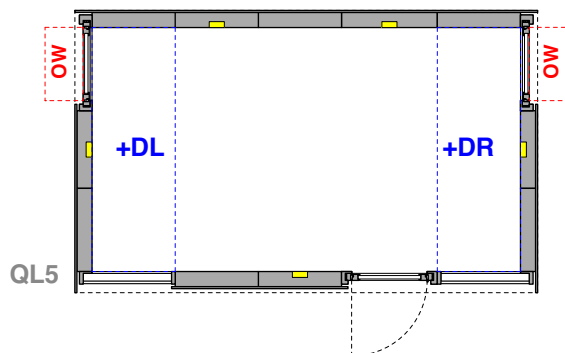
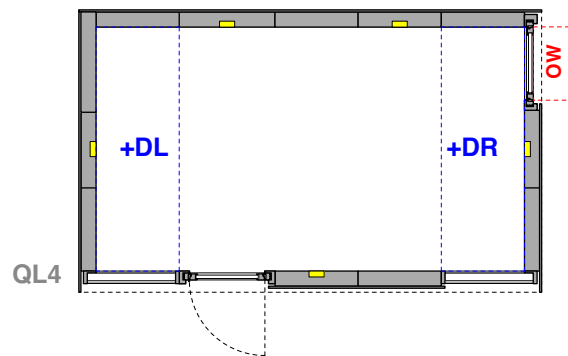
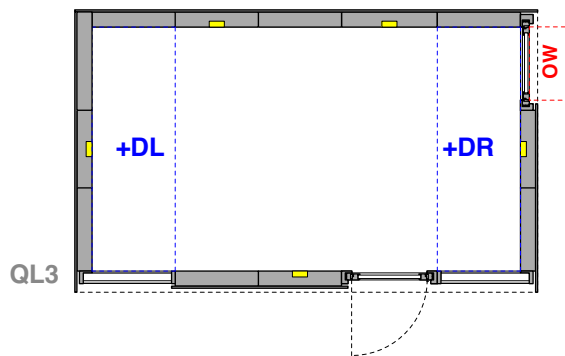
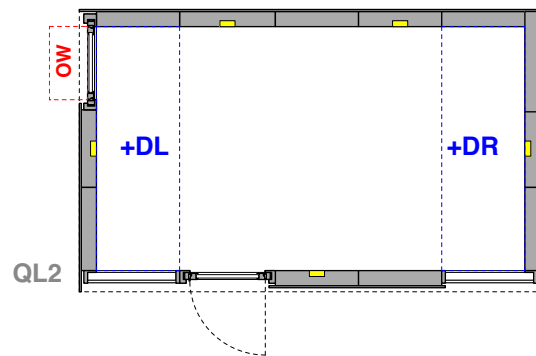
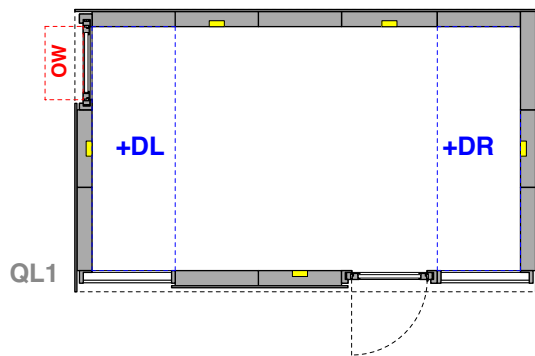

Key:

- OW** Opening window
- +DL** Optional oiled birch plywood desk on Left
- +DR** Optional oiled birch plywood desk on Right
- Cut-out for double socket

Example ordering code: QL1 +DR

Prices and Options:

QL1, QL2, QL3 and QL4 £18,000

QL5 and QL6 £18,750

Insulation upgrade £350

Oiled birch plywood desk £400

Delivery charges vary - please refer to final page

All prices include VAT, foundations and installation



Key:

- OW** Opening window
- +DL** Optional oiled birch plywood desk on Left
- +DR** Optional oiled birch plywood desk on Right
- Cut-out for double socket

Example ordering code: QL10 +DL

Prices and Options:

QL7 and QL8	£18,000
QL9 and QL10	£18,750
Insulation upgrage	£350
Oiled birch plywood desk	£400

Delivery charges vary - please refer to final page
All prices include VAT, foundations and installation

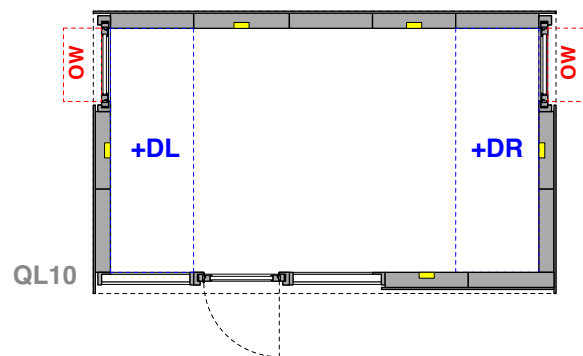
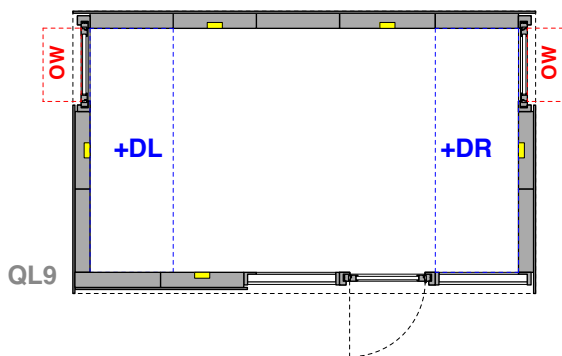
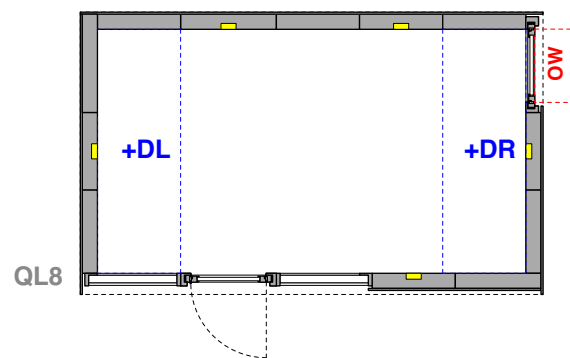
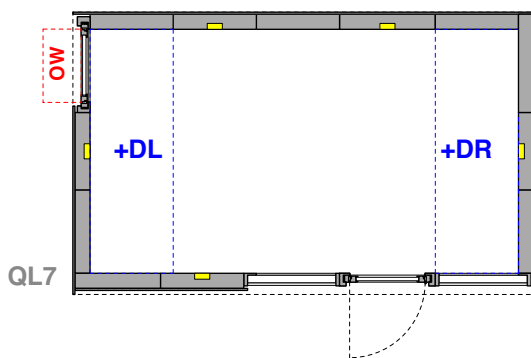

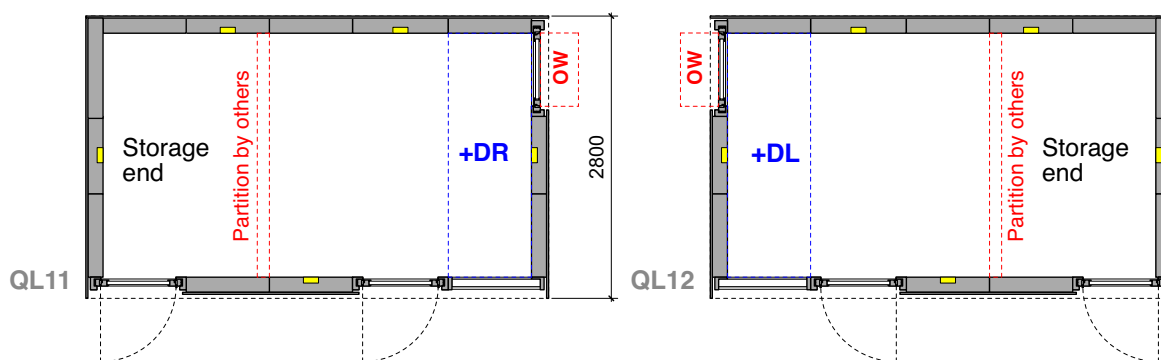

Key:

- OW** Opening window
- +DL** Optional oiled birch plywood desk on Left
- +DR** Optional oiled birch plywood desk on Right
- Cut-out for double socket

Example ordering code: QL11 +DR

Prices and Options:

QL11 and QL12 £18,000

Insulation upgrade £350

Oiled birch plywood desk £400

Delivery charges vary - please refer to final page

All prices include VAT, foundations and installation

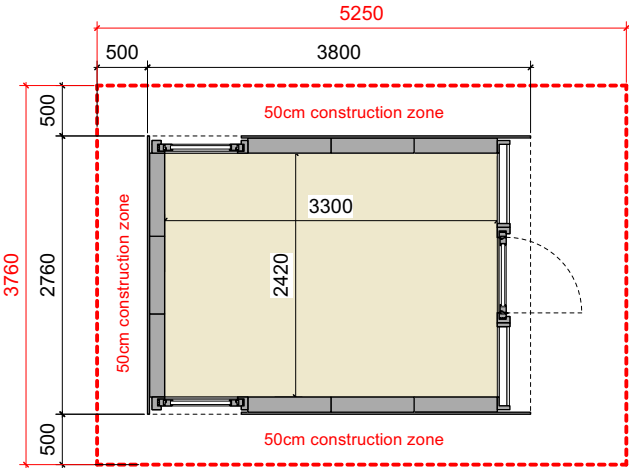

Mökki Tube Compact space required

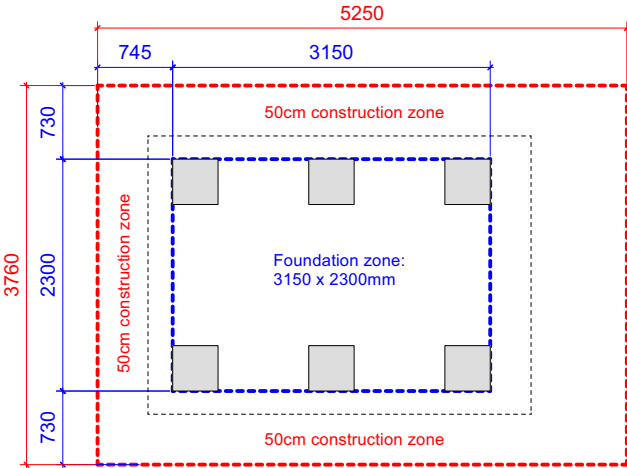

Mökki Tube Compact foundation area

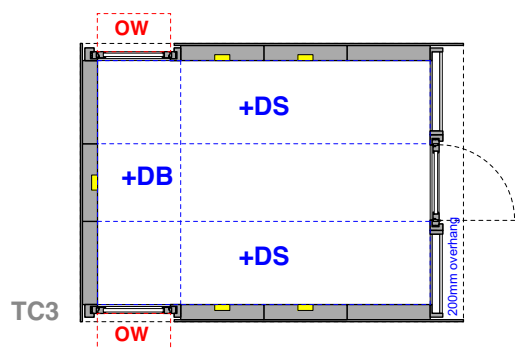
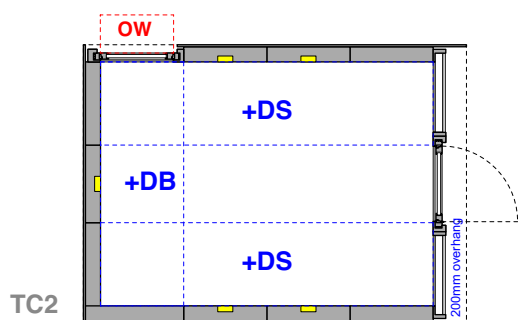
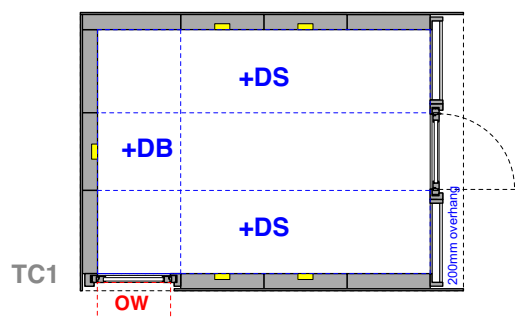

Key:

- OW** Opening window
- +DB** Standard oiled birch plywood desk to back
- +DS** Extra long oiled birch plywood desk to side
- Cut-out for double socket

Example ordering code: TC3 + DS

Prices and Options:

TC1 and TC2	£16,500
TC3	£17,250
Insulation upgrade	£300
Oiled birch plywood desk (DB)	£400
Extra long birch plywood desk (DS)	£750

Delivery charges vary - please refer to final page

All prices include VAT, foundations and installation

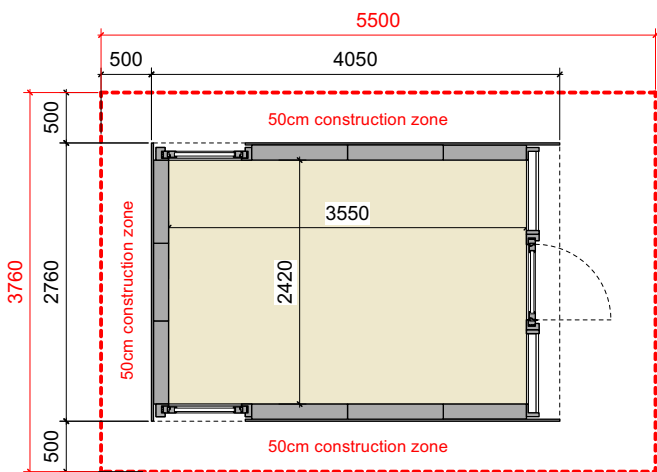

Mökki Tube Long space required

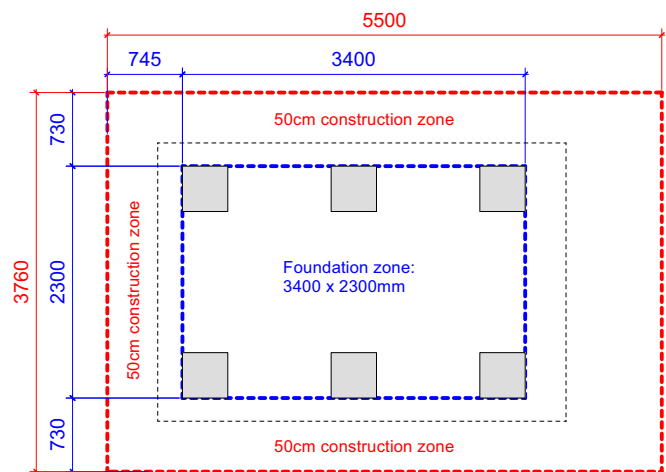

Mökki Tube Long foundation area

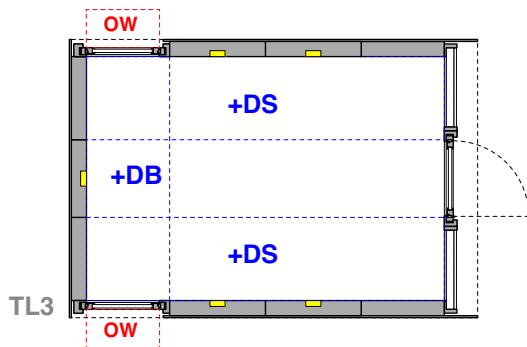
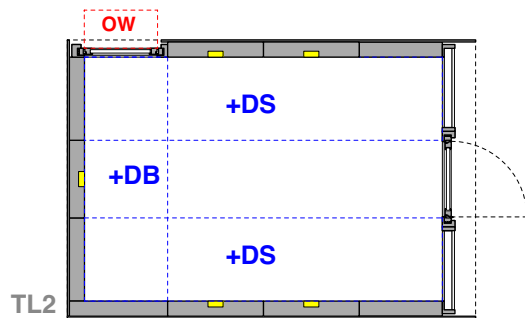
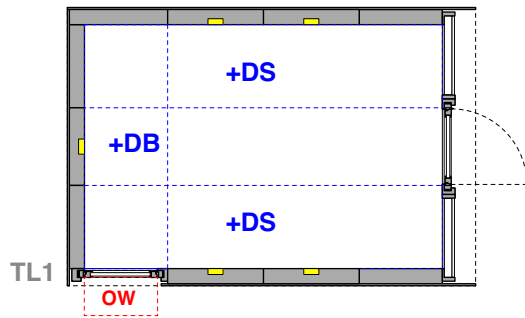

Key:

- OW** Opening window
- +DB** Standard oiled birch plywood desk to back
- +DS** Extra long oiled birch plywood desk to side
- Cut-out for double socket

Example ordering code: TL3 + DS

Prices and Options:

TL1 and TL2	£17,000
TL3	£17,750
Insulation upgrade	£350
Oiled birch plywood desk (DB)	£400
Extra long birch plywood desk (DS)	£750

Delivery charges vary - please refer to final page

All prices include VAT, foundations and installation

Delivery Cost

Being based in Devon, a large part of our costs is in logistics. It takes 2 transit-sized vans to deliver a Mokki. For jobs that are far-afield we also need to accommodate our installation team for the night.

As a rule of thumb we charge £7.50 per mile travelled from Totnes. We will agree a price with you based on your address prior to taking an order.

Some examples:

Plymouth	- £180
Exeter	- £225
Truro	- £570
Dorchester	- £585
Bath	- £765
Bristol	- £840
Newport	- £915
Cheltenham	- £1030
Reading	- £1235
Oxford	- £1385
West London	- £1425
East London	- £1590
Brighton	- £1730
Cambridge	- £1835

All prices include VAT

Payment Stages

Payment 1 - Deposit:	10% of base price	Payable at placing of order
Payment 2 - Pre-manufacture:	40% of base price	Payable approx 4 weeks before installation
Payment 3 - Pre-installation:	40% of base price plus extras	Payable approx 1 week before installation
Payment 4 - Completion:	10% of base price	Payable at key handover

All prices include VAT, foundations and installation.

Note: scalplings are to be supplied by the client.

Decision Timescale

You don't have to have made all the decisions about window positions, sockets or other extras until we go into manufacture (approx 4 weeks before installation). Around that time we will send you a drawing for your approval that confirms the layout and other details.

Lead-in times

Our studios are made to order. We are a small company with only one installation team so our lead-in times vary significantly depending on demand.

Minimum lead-in is approximately 8 weeks but please get in touch for the current situation. Jobs sometimes get delayed for various reasons so occasionally we have a slot to fill at short notice.

If you're in a hurry then please include a site address and some photos of the garden with your enquiry so we can get an idea of what's involved. Note that we only book in construction slots once we have received a 10% deposit.